

CASE INFORMATION

CASE PACKING ARRANGEMENT

WHEN GIVING PACKING ARRANGEMENT OF A CASE, ALWAYS GIVE THE NUMBER OF PACKAGES ALONG THE LENGTH OF CASE X NUMBER OF PACKAGES ALONG THE WIDTH OF CASE X NUMBER OF PACKAGES ALONG THE DEPTH OF CASE.

IN OTHER WORDS

THE PACKAGING ARRANGEMENT IS GIVEN IN THE SAME ORDER AS THE CASE DIMENSIONS – LENGTH X WIDTH X DEPTH.

EXAMPLES

SHOWN ARE NINE CASES – ALL THE SAME SIZE – ALL CONTAINING SIX (6) PACKAGES – ALL WITH DIFFERENT PACKING ARRANGEMENTS.

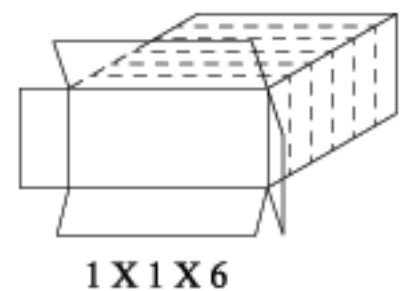
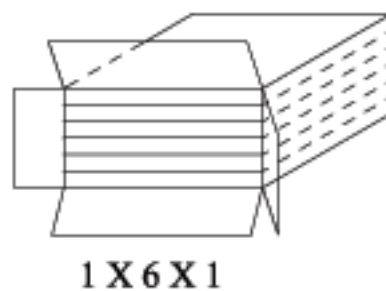
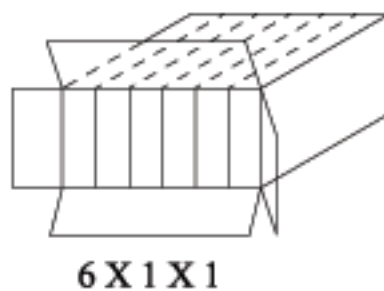
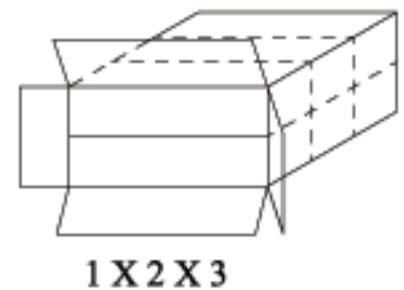
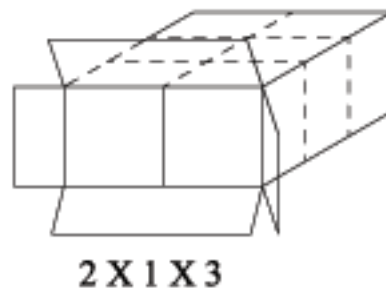
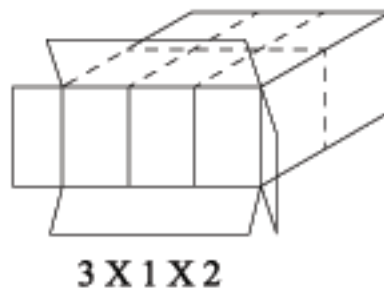
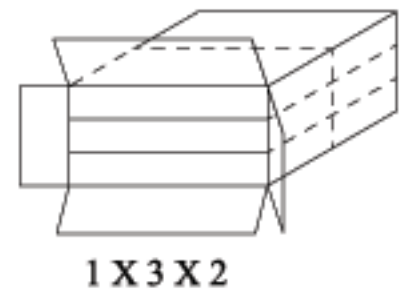
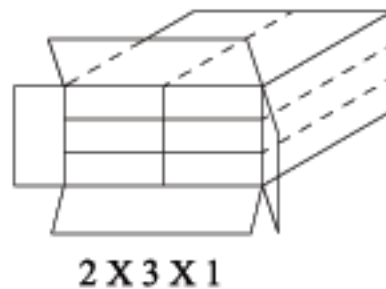
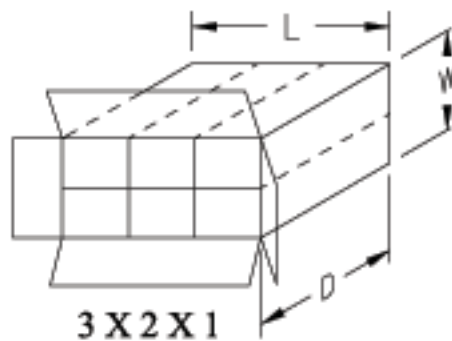

DOCUMENT NUMBER: **TG-1014-A**

TODD DICE



T.A.D. PACKAGING MACHINERY, INC.
10759 CIVIC CENTER DRIVE
RANCHO CUCAMONGA, CA 91730
PHONE (909) 476-0503 / FAX (909) 476-0573
WWW.TADPACKAGING.COM SALES@TADPACKAGING.COM

